

PIEDINO REGOLABILE IN OTTONE - FINITURA OTTONE LUCIDO

Codice	U.M.	Ø	Filetto	Articolo
2231001	Pezzi	mm.30	M10	0083
2231002	Pezzi	mm.40	M10	0083
2231003	Pezzi	mm.50	M10	0083
2231004	Pezzi	mm.50	M12	0083

**PIEDINO REGOLABILE IN OTTONE**

*Regolabile girevole ottone con gomma.
Finitura: ottone lucido.*

Codice	U.M.	Ø	Filetto	Articolo
2231050	Pezzi	mm.40	M10	0283
2231051	Pezzi	mm.50	M12	0283
2231052	Pezzi	mm.60	M12	0283

**PIEDINO REGOLABILE IN ACCIAIO - FINITURA CROMATO**

Codice	U.M.	Ø	Filetto	Articolo
2231007	Pezzi	mm.30	M10	0162

**PIEDINO REGOLABILE IN OTTONE CON PUNTA**

*Regolabile girevole ottone con punta.
Finitura: ottone lucido.*

Codice	U.M.	Ø	Filetto	Articolo
2231045	Pezzi	mm.40	M10	0282
2231046	Pezzi	mm.50	M12	0282

**PIEDINO IN ACCIAIO CROMATO CON BASE BOMBATA Ø MM.25 M8**

Codice	U.M.	Articolo
4481061	Pezzi	11.40.137.62

**SCIVOLO SILENZIOSO IN ACCIAIO CON FALSA VITE**

Finitura: nichelato.

Codice	U.M.	Ø	Articolo
2231018	Pezzi	mm.26	0183/27

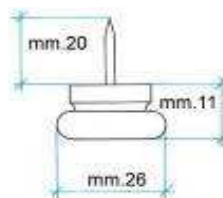
**SCIVOLO A SFERA OTTONATO Ø MM.30**

*Scivolo a sfera "occhio di bue".
Finitura: ottonato.*

Codice	U.M.	Articolo
2231180	Pezzi	0431



PIEDINO TONDO IN ABS ART.PI02 MITAL

Piedino in abs regolabile verniciato a forno, completo di vite M8xM40 passante.

Codice	U.M.	Finitura	Altezza	Articolo
2521151	Pezzi	Econichel	mm.100	PI02/C
2521150	Pezzi	Econichel	mm.120	PI02/B

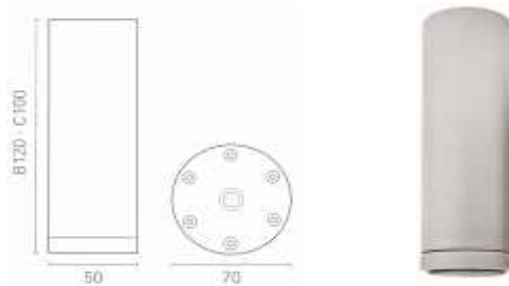

PIEDINO QUADRO IN ABS ART.PI01 MITAL

Piedino in abs regolabile verniciato a forno.

Codice	U.M.	Finitura	Altezza	Articolo
2521161	Pezzi	Econichel	mm.100	PI01/C
2521160	Pezzi	Econichel	mm.120	PI01/B

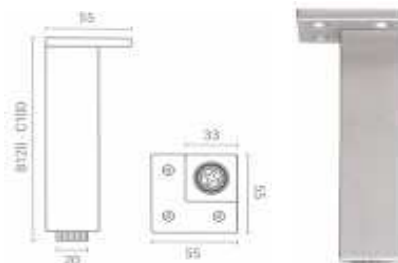

PIEDINO ZINCATO CON VITE MANART

Con piastra Ø 60 mm.

Fissaggio: viti 10MA standard o forata, o viti per legno.

Materiale: acciaio zincato: 28 mm. Regolazione in ABS.

Regolazione esterna.

Codice	U.M.	Altezza	Articolo
4511001	Pezzi	cm.10	117
4511002	Pezzi	cm.12	117
4511003	Pezzi	cm.15	117



PIEDE REGOLABILE CON SNODO D.50 M.10X70 PRST

Perno a sfera in acciaio zincato.

Base in tecnopolimero nero rinforzato fibre di vetro.

Antiscivolo in gomma durezza 85±5 shore.

Codice	U.M.	Articolo
4272448	Pezzi	6322230



PIEDE REGOLABILE CON SNODO PRSTX

Perno a sfera in acciaio inox.

Base in tecnopolimero nero rinforzato fibre di vetro.

Antiscivolo in gomma durezza 85±5 shore.

Base, perno e guarnizione antiscivolo forniti smontati.

Codice	U.M.	Misure	Articolo
4272451	Pezzi	D50 M.10X45	6325225
4272455	Pezzi	D50 M.12X70	6325250



PIEDE REGOLABILE CON SNODO PRST/80

*Perno a sfera in acciaio zincato.
Base in tecnopolimero nero rinforzato fibre di vetro.
Antiscivolo in gomma durezza 85±5 shore.
Base, perno e guarnizione antiscivolo forniti smontati.*



Codice	U.M.	Misure	Articolo
4272456	Pezzi	D80 M.12X125	6322560
4272460	Pezzi	D80 M.16X110	6322585

PIEDE REGOLABILE D.40 M.8X32 PRTR

In polietilene nero.

Codice	U.M.	Articolo
4272449	Pezzi	7321753



PIEDE REGOLABILE D.50 M.10X32 PRTN

In polietilene nero.

Codice	U.M.	Articolo
4272450	Pezzi	7321585



TAPPO NERO ALETTATO IN PE

Codice	U.M.	Diametro	Articolo
4481055	Centinaia	mm.40	11.01.116.02
4481056	Centinaia	mm.50	11.01.119.02
4481057	Centinaia	mm.60	11.01.120.02



PUNTALE NERO ALETTATO 0154/A

Codice	U.M.	Diametro	Articolo
7631041	Centinaia	mm.10	0154/A
7631042	Centinaia	mm.12	0154/A
7631043	Centinaia	mm.14	0154/A
7631044	Centinaia	mm.16	0154/A
7631045	Centinaia	mm.18	0154/A
7631046	Centinaia	mm.20	0154/A
7631047	Centinaia	mm.22	0154/A
7631048	Centinaia	mm.24	0154/A
7631049	Centinaia	mm.25	0154/A
7631051	Centinaia	mm.28	0154/A
7631052	Centinaia	mm.30	0154/A
7631053	Centinaia	mm.32	0154/A



PUNTALE TAPPO NERO 0154/P

Codice	U.M.	Diametro	Articolo
7631010	Centinaia	mm.12	0154/P
7631011	Centinaia	mm.14	0154/P
7631012	Centinaia	mm.16	0154/P
7631013	Centinaia	mm.18	0154/P
7631014	Centinaia	mm.20	0154/P
7631015	Centinaia	mm.22	0154/P
7631016	Centinaia	mm.24	0154/P
7631017	Centinaia	mm.28	0154/P



PUNTALE CALZANTE NERO 0151/NU

Codice	U.M.	Diametro	Articolo
7631028	Centinaia	mm.10	0151/NU
7631000	Centinaia	mm.12	0151/NU
7631001	Centinaia	mm.14	0151/NU
7631002	Centinaia	mm.16	0151/NU
7631003	Centinaia	mm.18	0151/NU
7631004	Centinaia	mm.20	0151/NU
7631005	Centinaia	mm.24	0151/NU
7631006	Centinaia	mm.28	0151/NU



TAPPO NERO

Codice	U.M.	Dimensioni		Articolo
18902001	Pezzi	mm.30x30	M10	3306.17034
18902003	Pezzi	mm.40x40	M10	3306.17043
18902004	Pezzi	mm.40x40	M12	3306.17044



TAPPO TUBOLARE NERO QUADRO ALETTATO IN PE

Codice	U.M.	Misure	Articolo
4481001	Centinaia	mm.15x15	11.03.122.02
4481006	Centinaia	mm.20x20	11.03.125.02
4481013	Centinaia	mm.25x25	11.03.127.02
4481021	Centinaia	mm.30x30	11.03.128.02
4481030	Centinaia	mm.35x35	11.03.129.02
4481031	Centinaia	mm.40x40	11.03.130.02
4481032	Centinaia	mm.50x50	11.03.131.02
4481033	Centinaia	mm.60x60	11.03.132.02



TAPPO PLASTICA MM.40X40 M.10

Codice	U.M.	Articolo
2231170	Pezzi	0168



SUPPORTO ZAMA CENTRALE

Reggitubo zama centrale regolabile per tubo mm. 15X30.

Codice	U.M.	Finitura	Articolo
2231070	Pezzi	Cromato	0777
2231071	Pezzi	Oro	0777

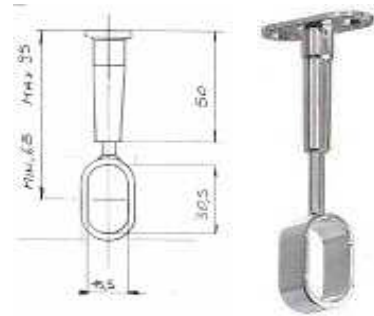

SUPPORTO ZAMA

Reggitubo zama pressofusa per tubi ovali.
Finitura cromato

Codice	U.M.	Colore	Articolo
2231073	Pezzi	Cromato	0755
2231074	Pezzi	Oro	0755

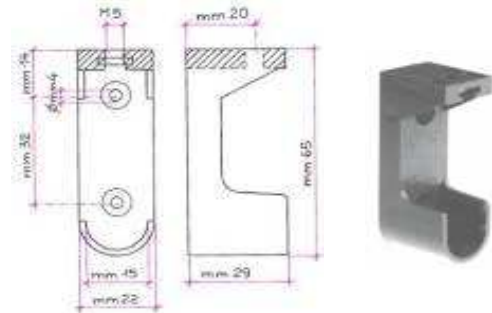

REGGITUBO PLASTIFICATO BIANCO

Reggitubo plastica per tubi ovali con perno.

Codice	U.M.	Articolo
2231075	Centinaia	0765

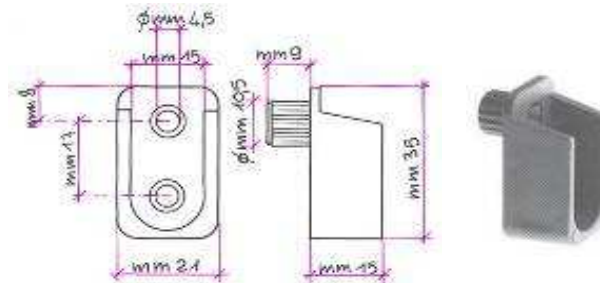

TUBO OVALE PER APPENDIABITI O ARREDAMENTO MANART

Lunghezza: mt.3
Spessore: mm.0,7

Codice	U.M.	Finitura	Misure	Articolo
4511020	Pezzi	Cromato	mm.30x15	M709
4511023	Pezzi	Ottonato	mm.30x15	M709



APPENDIABITI ESTRAIBILE CROMATO

Portabiti realizzato nella finitura nera con tubi cromati.

Codice	U.M.	Misure	Articolo
4511070	Pezzi	cm.30	M753
4511071	Pezzi	cm.35	M753
4511072	Pezzi	cm.40	M753



BUSSOLA IN OTTONE LUCIDO CON TAGLIO CACCIAVITE

Codice	U.M.	Misura	Articolo
4511060	Centinaia	M.4 mm.8x12	875
4511061	Centinaia	M.5 mm.10x12	876
4511062	Centinaia	M.6 mm.10x14	877



BUSSOLA OTTONE LUCIDO M.5 Ø MM.7

Codice	U.M.	Finitura	Articolo
2231194	Centinaia	Ottone Luc.	11.0621
2231195	Centinaia	Nichelata	11.0622
2231196	Centinaia	Bronzata	11.0623

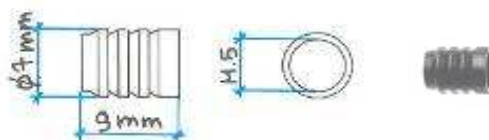

MENSOLINA M.5 CON GOMMA

Mensolina reggipiano ottone tornito Ø mm.7, con perno filettato M.5, con guarnizione in gomma.

Codice	U.M.	Finitura	Articolo
2231140	Centinaia	Ottone lucido	0624
2231141	Centinaia	Ottone nichelato	0624



MENSOLINA M.5 CON VENTOSA TRASPARENTE

Reggipiano per cristalli con perno filettato M.5. Colore: trasparente.

Codice	U.M.	Articolo
2231145	Centinaia	0618

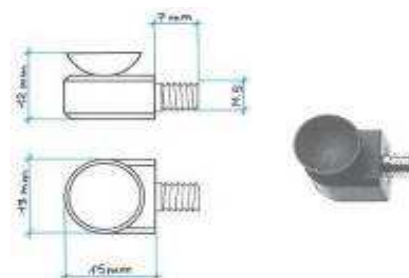

MENSOLINA REGGIPIANO

Mensolina reggipiano stampata doppia. Misura: Ø mm5/5

Codice	U.M.	Finitura	Articolo
2231147	Centinaia	Zincata	0672
2231148	Centinaia	Bronzata	0672
2231149	Centinaia	Ottonata	0672

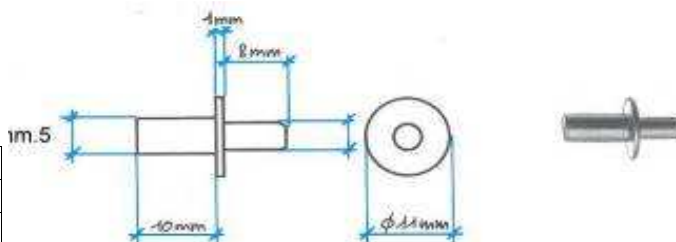

MENSOLINA REGGIPIANO MEZZA TONDA M.5

Mensolina reggipiano ottone tornito mezza tonda, con perno filettato M.5.

Codice	U.M.	Finitura	Articolo
2231190	Centinaia	Ottone Luc.	01.0619
2231191	Centinaia	Nichelata	11.0620
2231192	Centinaia	Bronzata	21.0619

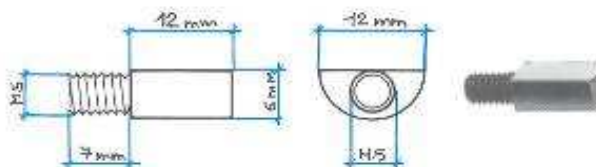

MENSOLINA REGGIPIANO MEZZA TONDA OTTONE LUCIDO

Mensolina reggipiano ottone tornito mezza tonda, con perno.

Codice	U.M.	Articolo
2231187	Centinaia	01.0075

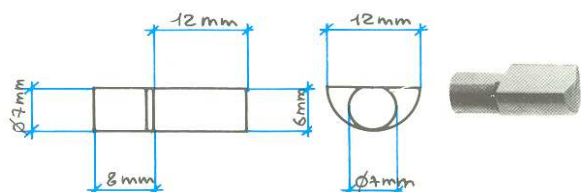

MENSOLA TONDA M.5

Mensolina reggipiano ottone tornito Ø mm.7, con perno filettato M.5.

Codice	U.M.	Finitura	Articolo
2231184	Centinaia	Ottone Luc.	01.0620
2231185	Centinaia	Nichelata	11.0620
2231186	Centinaia	Ottone Br.	21.0620

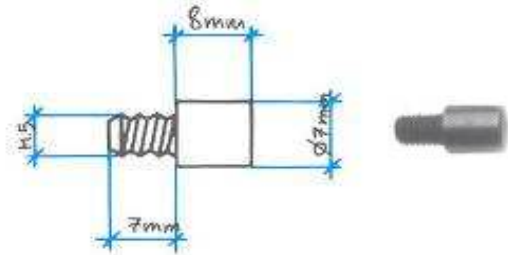

PORTARIPIANO NERO/NICHELATO

Portaripiano interparete zama mm.20 a vite, tassello espansore nylon.
Finitura: nichelato. Colore: nero.
Misura vite: Ø mm.0,6

Codice	U.M.	Articolo
2231135	Pezzi	0921

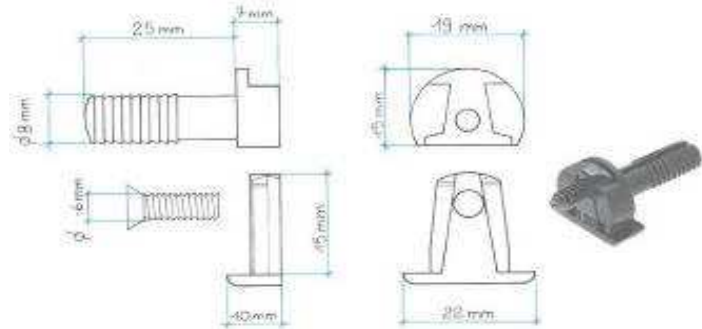

CRICCHETTO CALAMITA NICHELATO

Magnetico da applicare in ottone per porte scorrevoli. Forza Kg.12.

Codice	U.M.	Articolo
2231089	Pezzi	0656

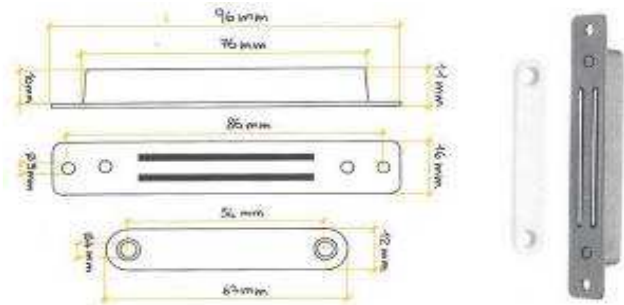

CRICCHETTO A CALAMITA PER SPORTELLI PESANTI

Magnetico da incasso per sportelli pesanti.
Forza Kg.12.
Colore marrone.

Codice	U.M.	Articolo
2231097	Pezzi	0650

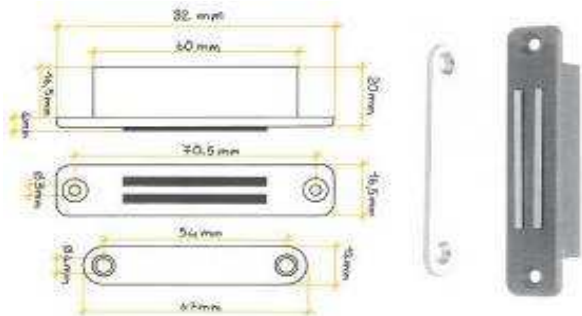

CRICCHETTO A CALAMITA PER SPORTELLI PESANTI

Magnetico da applicare per sportelli pesanti.
Forza Kg.12.
Colore marrone.

Codice	U.M.	Articolo
2231098	Pezzi	0652

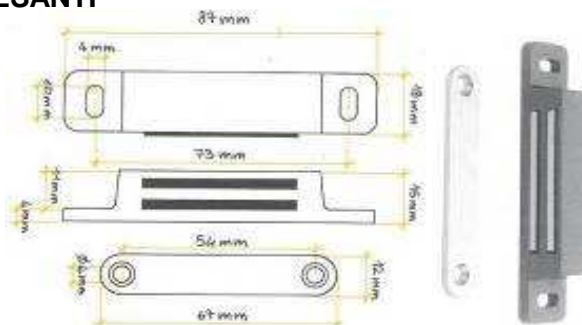

CHIUSURA MAGNETICA GRANDE NERA

Magnetico da applicare
per sportelli pesanti.
Forza Kg.12
Colore nero

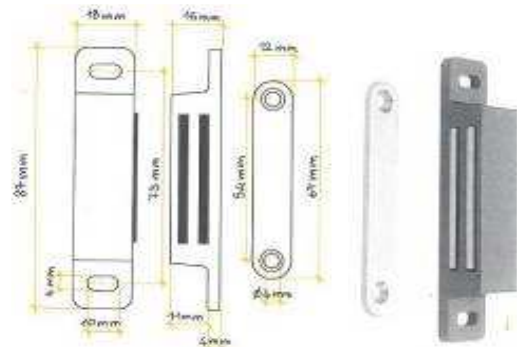

Codice	U.M.	Articolo
2231106	Pezzi	0652

CRICCHETTO A CALAMITA MARRONE CON CONTROPIASTRA

Magnetico da applicare
con contropiastra 2 fori.
Forza Kg.4
Colore marrone.

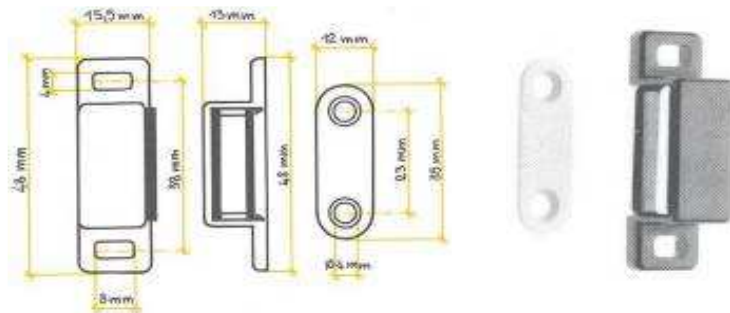

Codice	U.M.	Articolo
2231100	Pezzi	0782

CRICCHETTO A SCATTO PUSH BIANCO

Cricchetto a scatto regolabile
con magnete neodimio kg.5.
Fissaggio con basetta a vite.

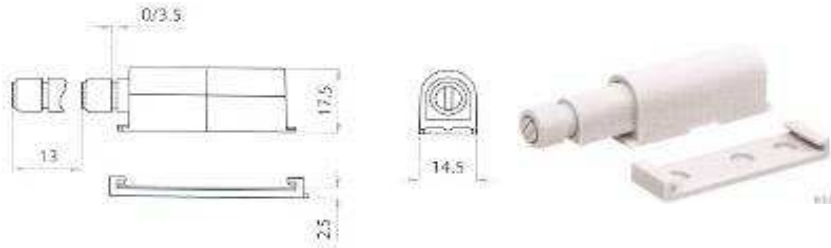

Codice	U.M.	Articolo
2231096	Pezzi	0691

CRICCHETTO CALAMITA 647/648 K6

Chiusura magnetica regolabile con spina.

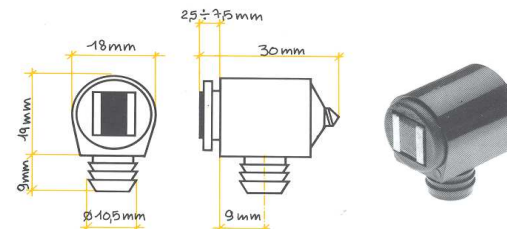

Codice	U.M.	Articolo
2231090	Pezzi	0647/0648

CHIUSURA MAGNETICA MARRONE K10

Magnetico regolabile con spina premontaggio.
Inc.646. Forza K10

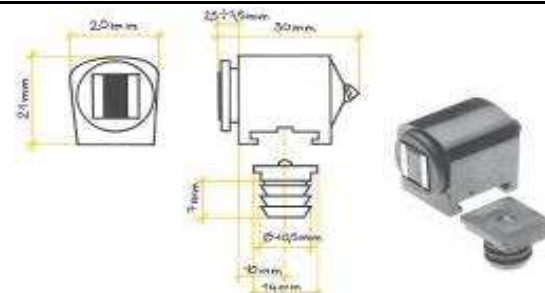

Codice	U.M.	Articolo
2231104	Pezzi	180642

CRICCHETTO CON RULLO VIPLA

Cricchetto in metallo con rullo vipla.
Finitura: ferro zincato.

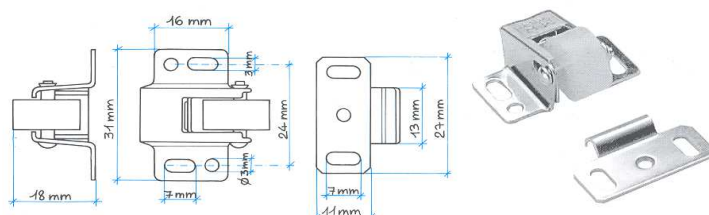

Codice	U.M.	Articolo
2231107	Pezzi	01.0057

CRICCHETTO OTTONE IDEAL MM.8X44

*Cricchetto ottone profilato 2 sfere.
Finitura: ottone lucido.*



Codice	U.M.	Articolo
2231108	Pezzi	01.0162

INCONTRO PER CRICCHETTI

Contropiastra in ferro zincato mm.15.

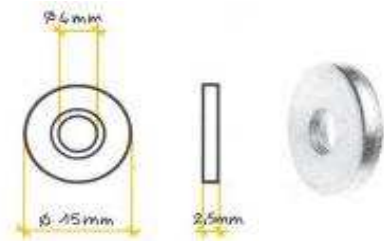

Codice	U.M.	Articolo
2231088	Centinaia	0631

INCONTRO CON VITE INCORPORATA

Contropiastra in ferro zincato con vite.

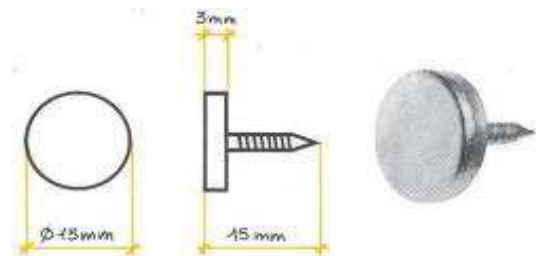

Codice	U.M.	Articolo
2231099	Centinaia	0646

SERRATURA REDOSSO FERRO VECCHIO METAL STYLE

Passo N chiave piccola.

Codice	U.M.	Misure		Articolo
5931003	Pezzi	mm.30	Destra	MG9094
5931004	Pezzi	mm.30	Sinistra	MG9096
5931001	Pezzi	mm.40	Destra	MG9102
5931002	Pezzi	mm.40	Sinistra	MG9104
5931005	Pezzi	mm.60	Destra	MG9116
5931007	Pezzi	mm.70	Destra	MG9122
5931008	Pezzi	mm.70	Sinistra	MG9124



SERRATURA REDOSSO FERRO VECCHIO METAL STYLE

Passo N chiave piccola.

Codice	U.M.	Misure		Articolo
5931009	Pezzi	mm.20	Ambidestro	MG9000

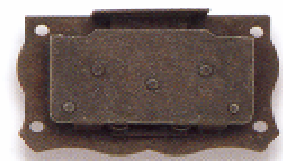

ASTA ESAGONALE PER SERRATURA METAL STYLE

Codice	U.M.	Misure	Finitura	Articolo
593R001	Pezzi	mm.1000	Ott.lucido	MG9325
593R003	Pezzi	mm.1500	Ott.lucido	MG9335



ATTACCAGLIA PER PENSILI

Lastrina per pensili regolabile.
Finitura: ferro zincato

Codice	U.M.	Articolo
2231039	Pezzi	0147

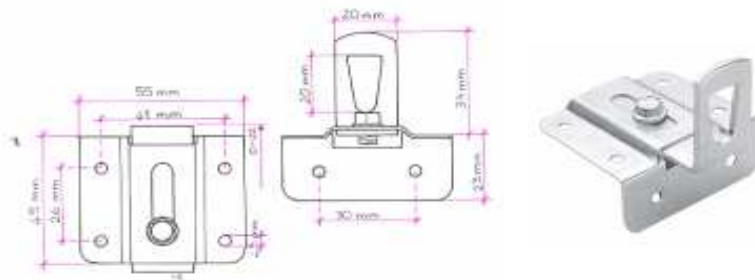

ATTACCAGLIA PER PENSILI DESTRA E SINISTRA

Lastrina per pensili stampata, destra e sinistra.
Finitura: ferro zincato

Codice	U.M.	Articolo
2231043	Pezzi	00276

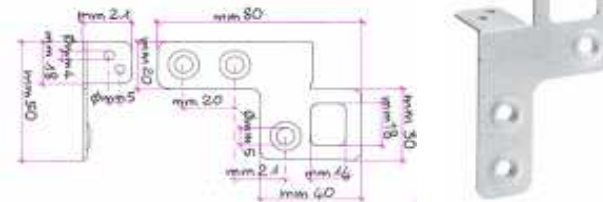

REGGIPENSILE REGOLABILE

Supporto per pensili in nylon,
registrabile in 3 direzioni.
Parte portante in acciaio.
Fissaggio a vite, utilizzabile sia
con tassello a gancio, sia scorrevole
su barra.

Codice	U.M.	Colore	Articolo
2231055	Pezzi	Marrone	0415
2231056	Pezzi	Bianco	0415

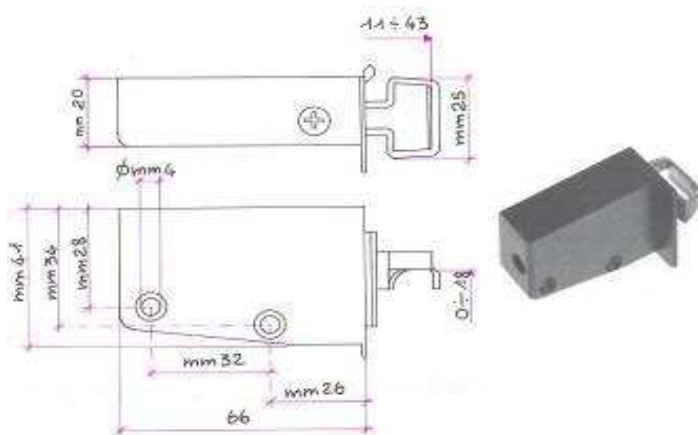

BOCCHETTA PASSACAVI MM.60

Bocchetta passacavi Ø mm.60 ad
apertura regolabile.

Codice	U.M.	Colore	Articolo
2231151	Pezzi	Marrone	0960
2231152	Pezzi	Nero	0960
2231153	Pezzi	Cromo	0960

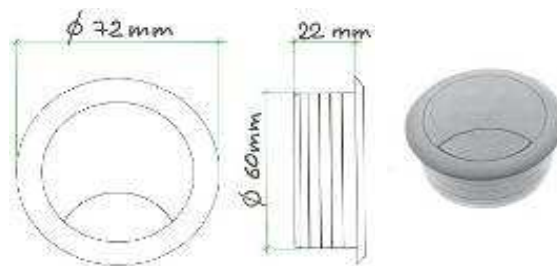

BOCCHETTA PASSACAVI MM.80 MARRONE

Bocchetta passacavi Ø mm.80 ad
apertura regolabile.

Codice	U.M.	Articolo
2231150	Pezzi	0962

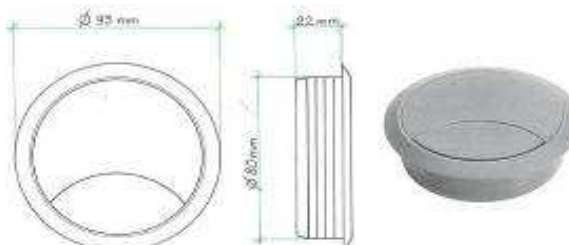

BARILOTTO IN ACCIAIO CON TAGLIO A CACCIAVITE MM.12X14 M.6

Codice	U.M.	Misure	Articolo
2231009	Centinaia	mm12X14	0702



GHIERA TROPICAL DIAM. MM.30 M.10

Rondella in metallo filettata.
Finitura: ferro tropicalizzato.



Codice	U.M.	Articolo
2231235	Centinaia	03.0120

PATTINO FIBRA MARRONE

Pattino in plastica per scorrevoli.

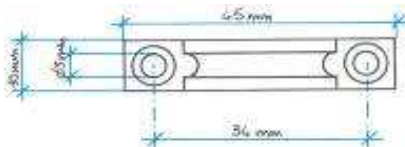

Codice	U.M.	Articolo
2231015	Centinaia	0180

FELTRINO AUTOADESIVO 0981/RT

Codice	U.M.	Diametro	Colore	Articolo
7631095	Centinaia	mm.22	Noce	0981/RT
7631100	Centinaia	mm.20	Bianco	0981/RT
7631101	Centinaia	mm.22	Bianco	0981/RT
7631102	Centinaia	mm.26	Bianco	0981/RT



CONFEZIONE FELTRINI AUTOADESIVI NOCE TONDI 0977/UP

Codice	U.M.	Diametro	Pezzi	Articolo
7631104	Conf.	mm.20	12	0977/UP
7631105	Conf.	mm.22	12	0977/UP
7631107	Conf.	mm.26	8	0977/UP
7631109	Conf.	mm.30	6	0977/UP
7631110	Conf.	mm.32	6	0977/UP



CONFEZIONE FELTRINI AUTOADESIVI NOCE 0977/UP

Codice	U.M.	Misure	Pezzi	Articolo
7631121	Conf.	mm.20X20	12	0977/UP
7631122	Conf.	mm.25X25	9	0977/UP
7631123	Conf.	mm.30X30	6	0977/UP
7631124	Conf.	mm.35X35	4	0977/UP
7631130	Conf.	mm.25X20	12	0977/UP
7631132	Conf.	mm.30X20	6	0977/UP
7631133	Conf.	mm.35X25	6	0977/UP
7631134	Conf.	mm.40X35	4	0977/UP
7631135	Conf.	mm.80X35	2	0977/UP



PARACOLPO TRASPARENTE CONF. PZ 50 5520/PL

Codice	U.M.	Articolo
7631136	Conf.	5520PL

