

PINZA PORTA ELETTRDI PARVA 200/A**EN60974-11**

Corpo in ottone pressofuso e rivestimenti isolanti in materiali termoindurenti, ininfiammabili e anticalore.
Serraggio cavo mediante grani a cava esagonale.
Molla a compressione isolata.

Codice	U.M.	Articolo
3192065	Pezzi	PIN000006



A	A	∅	⊗	↓	↔	CLASS
60%	35%	mm	mm ²	gr	mm	B
150	200	2-3,2	16-25	325	210	

PINZA PORTA ELETTRDI PERFECTA 3 350/A**EN60974-11**

Corpo in ottone pressofuso e rivestimenti isolanti in materiali termoindurenti, ininfiammabili e anticalore.
Serraggio cavo mediante grani a cava esagonale.
Molla a compressione isolata.

Codice	U.M.	Articolo
3192066	Pezzi	PIN000022



A	A	∅	⊗	↓	↔	CLASS
60%	35%	mm	mm ²	gr	mm	B
200	250	2,5-4	25-35	500	240	

PINZA PORTA ELETTRDI PERFECTA 5 500/A**EN60974-11**

Corpo in ottone pressofuso e rivestimenti isolanti in materiali termoindurenti, ininfiammabili e anticalore.
Serraggio cavo mediante grani a cava esagonale.
Molla a compressione isolata.

Codice	U.M.	Articolo
3192067	Pezzi	PIN000045



A	A	∅	⊗	↓	↔	CLASS
60%	35%	mm	mm ²	gr	mm	B
250	300	3,2-5	35-50	610	263	

PINZA PORTA ELETTRDI URANIA 400**EN60974-11**

Corpo in ottone pressofuso e rivestimenti isolanti in materiali termoindurenti, ininfiammabili e anticalore.
Serraggio cavo mediante grani a cava esagonale.
Molla a compressione isolata.

Codice	U.M.	Articolo
3192068	Pezzi	PIN000070



A	A	∅	⊗	↓	↔	CLASS
60%	35%	mm	mm ²	gr	mm	B
200	250	2,5-4	25-35	425	230	

PINZA PORTA ELETTRDI SOLARE 5**EN60974-11**

Corpo in ottone pressofuso e rivestimenti isolanti in materiali termoindurenti, ininfiammabili e anticalore.

Codice	U.M.	Articolo
3192070	Pezzi	PIN00 111



A	A	∅	⊗	↓	↔	CLASS
60%	35%	mm	mm ²	gr	mm	B
250	300	3,2-5	35-50	520	247	

PINZA MASSA IN OTTONE GAMMA 2

Morsetto di massa costruito in ottone pressofuso.
Shunt in treccia di rame per una condurrività garantita.
Serraggio del cavo con lamella in rame avvolgibili malleabile
e serracavo in ottone.

Codice	U.M.	Articolo
3192073	Pezzi	MRS000010



A	A				
60%	35%	mm ²	mm	mm	gr
400	500	70-95	65	180	540

PINZA MASSA NEVADA 2

Morsetto di massa con struttura in acciaio trattato antiossidazione.
Contatti in ottone ramato e treccia in rame.
Serraggio del cavo con lamella in rame avvolgibili e serracavo in
acciaio ramato.

Codice	U.M.	Articolo
3192075	Pezzi	MRS000018



A	A				
60%	35%	mm ²	mm	mm	gr
200	250	25-35	58	170	225

PINZA MASSA NEVADA 3

Morsetto di massa con struttura in acciaio trattato antiossidazione.
Contatti in ottone ramato e treccia in rame.
Serraggio del cavo con lamella in rame avvolgibili e serracavo in
acciaio ramato.

Codice	U.M.	Articolo
3192076	Pezzi	MRS000028



A	A				
60%	35%	mm ²	mm	mm	gr
300	400	50-70	73	200	330

PINZA MASSA NEVADA 5

Morsetto di massa in lamiera di acciaio stampato elettrozincato.
Contatti in ottone ramato basculanti e treccia in rame.
Serraggio del cavo con lamella in rame avvolgibili e serracavo
in ottone.

Codice	U.M.	Articolo
3192077	Pezzi	MRS000039



A	A				
60%	35%	mm ²	mm	mm	gr
400	500	70-95	95	210	590

MARTELLINA SCORIE CON MANICO IN FERRO

Martellina in acciaio con punta temperata, manico in ferro.
Lunghezza: cm.315 mm
Peso: 250.

Codice	U.M.	Articolo
3192086	Pezzi	F11808S



CONNETTORE TEXAS MASCHIO**EN 60974-12**

Connettore per giunzione cavi di saldatura.
Corpo in ottone, rivestimento isolante in materiale elastomerizzato, resistente al calore e all'umidità con resistenza di isolamento superiore a 2M.

Codice	U.M.	Texas	Articolo
3192080	Pezzi	25	GCV000062
3192082	Pezzi	50	GCV000072
3192084	Pezzi	70	GCV000082



A	6-0%	mm ²	mm	gr
25	200	16-25	81	50
50	300	35-50	103	130
70	400	50-70	115	170

CONNETTORE TEXAS FEMMINA**EN 60974-12**

Corpo in ottone, rivestimento isolante in materiale elastomerizzato, resistente al calore e all'umidità con resistenza di isolamento superiore a 2M.

Codice	U.M.	Texas	Articolo
3192081	Pezzi	25	GCV000092
3192083	Pezzi	50	GCV000102
3192085	Pezzi	70	GCV000113



A	6-0%	mm ²	mm	gr
25	200	16-25	71	45
50	300	35-50	89	125
70	400	50-70	107	180

INNESTO PANNELLO FEMMINA TEXAS**EN 60974-12**

Presa a pannello per connessione rapida di pinze/morsetti alla macchina saldatrice.

Corpo in ottone con ghiera esterna in materiale termoindurente ininfiammabile e anticalore.

Codice	U.M.	Texas	Articolo
3192372	Pezzi	25	GCV000092
3192373	Pezzi	50	GCV000102



A	6-0%	mm ²	mm	mm	gr
25	200	16-25	30	32	45
50	300	35-50	38	48	120

MORSETTO CAPOCORDA

Per serraggio cavo con viti.

Codice	U.M.	Tipo	Articolo
3192090	Pezzi	A/16	GCV000001
3192091	Pezzi	A/25	GCV000002
3192092	Pezzi	A/35	GCV000003
3192093	Pezzi	A/50	GCV000004
3192094	Pezzi	A/75	GCV000005



	mm	mm
A/16	16	10
A/25	25	10
A/35	35	14
A/50	50	14
A/75	95	16

CAVO IN RAME SARFLEX PVC

Cavo unipolare extraflessibile in rame con rivestimento in PVC (H07RVK). Temperatura max di esercizio: 70°C sul conduttore. Marcatura: SARFLEX

Codice	U.M.	Diametro	Articolo
3192095	Metri	mm.16	CAV000007
3192096	Metri	mm.25	CAV000011
3192097	Metri	mm.35	CAV000018
3192098	Metri	mm.50	CAV000025

**ACCESSORI PER SALDATURA KING C TEXAS 25**

Completo di: Pinza perfecta 3, morsetto Nevada 3, connettori Texax da 25, cavo welding assemblato Ø 25, schermo, vetri, martellina e spazzola.

Codice	U.M.	Articolo
3192391	Pezzi	KIT000079

**TORCIA PER SALDATURA MIG MAG ERGOPLUS 15 MT.4 SPINE MOBILI**

Una torcia robusta che unisce alle qualità di compattezza e leggerezza una grande affidabilità.
Snodo per facilitare la curvatura del cavo.
Fornita di serie con attacco Euro.
Raffreddamento ad aria.
Filo Ø mm.0,6-0,8-0,9-1,0
Ciclo di lavoro: 180A CO2 150A mix 60%.

Codice	U.M.	Articolo
9562373	Pezzi	MA7044

**TORCIA PER SALDATURA MIG MAG ERGOPLUS 25 MT.4 SPINE MOBILI**

Raffreddamento ad aria.
Filo Ø mm.0,8-0,9-1,0-1,2
Ciclo di lavoro: 230A CO2 200A mix 60%.

Codice	U.M.	Articolo
9562378	Pezzi	MA7244

**TORCIA PER SALDATURA MIG MAG ERGOPLUS 36 MT.4 SPINE MOBILI**

Raffreddamento ad aria.
Filo Ø mm.0,8-0,9-1,0-1,2-1,6
Ciclo di lavoro: 340A CO2 3A mix 60%.

Codice	U.M.	Articolo
9562383	Pezzi	MA7444



TORCIA PER SALDATURA MIG MAG ERGOPLUS 500 MT.4 SPINE MOBILI

La ERGOPLUS 500 è la torcia con raffreddamento ad acqua più diffusa al mondo. Intercambiabile con le torce prodotte dalle maggiori marche europee, soddisfa la maggior parte delle richieste del saldatore professionista.

Punta guidafile di serie in CuCrZr.

Portapunta in rame al Tellurio.

Snodo collegato alla guaina esterna per una incredibile maneggevolezza.

Fornita di serie con attacco Euro.

Raffreddamento ad acqua.

Filo Ø mm.1,0-1,2-1,6-2,0-2,4

Ciclo di lavoro: 500A CO2 450A mix 60%.



Codice	U.M.	Articolo
9562405	Pezzi	MA7844

ADATTATORE EURO/TW-MK

Codice	U.M.	Articolo
9562020	Pezzi	AS0019



AS0019

GUAINA GUIDAFILO ACCIAIO RIVESTITO MT.4,4

Codice	U.M.	Diametro	Colore	Articolo
9562302	Pezzi	0,6-0,9	Blu	GM0501
9562304	Pezzi	1,0-1,2	Rossa	GM0511
9562312	Pezzi	1,2-1,6	Gialla	GM0541

**GUAINA MT.4,6 (1,0-1,2) EURO/TW-MK ROSSA**

Codice	U.M.	Diametro	Articolo
9562284	Pezzi	1,0-1,2	GM0012

GUAINA PTFE MT.4,5 (1,0-1,2) EURO ROSSA

Codice	U.M.	Diametro	Articolo
9562318	Pezzi	1,0-1,2	GM0611

**PUNTA GUIDAFILO PER MIG M6 6X25**

Codice	U.M.	Diametro	Articolo
9562473	Pezzi	mm.0,6	MD000806
9562474	Pezzi	mm.0,8	MD000808



PUNTA GUIDAFILO PER MIG MAG M6X28

Codice	U.M.	Diametro	Articolo
9562480	Pezzi	mm.0,8	MD000908
9562482	Pezzi	mm.1,0	MD000910
9562483	Pezzi	mm.1,2	MD000912
9562484	Pezzi	mm.1,6	MD000916

**PUNTA GUIDAFILO PER MIG M8X30**

Codice	U.M.	Diametro	Articolo
9562465	Pezzi	mm.0,8	MD000508
9562467	Pezzi	mm.1,0	MD000510
9562468	Pezzi	mm.1,2	MD000512
9562470	Pezzi	mm.1,6	MD000516

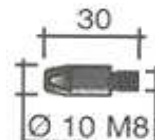
**PUNTA GUIDAFILO PER TWECO 2-4**

Codice	U.M.	Diametro	Articolo
9562461	Pezzi	mm.0,8	MD000408
9562462	Pezzi	mm.1,0	MD000410
9562463	Pezzi	mm.1,2	MD000412
9562464	Pezzi	mm.1,6	MD000416

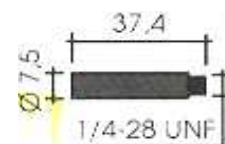
**UGELLO PER TORCIA MIG MAG MM.12 PER PLUS 15**

Codice	U.M.	Articolo
9562419	Pezzi	MC0018

**UGELLO PER TORCIA MIG MAG MM.13 PER PLUS 15**

Codice	U.M.	Articolo
9562447	Pezzi	MC0266

**UGELLO PER TORCIA MIG MAG MM. 15 PER PLUS 25**

Codice	U.M.	Articolo
9562422	Pezzi	MC0023

**UGELLO PER TORCIA MIG MAG MM.16 PER PLUS 36**

Codice	U.M.	Articolo
9562424	Pezzi	MC0027

**UGELLO PER TORCIA MM. 16 PER ERGOPLUS 500**

Codice	U.M.	Articolo
9562449	Pezzi	MC0268

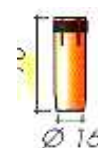

UGELLO GAS PER TWECO 2-4 MM.16

Codice	U.M.	Articolo
9562431	Pezzi	MC0040

**BOCCOLA ISOLANTE PER TWECO 2-4**

Codice	U.M.	Articolo
9562427	Pezzi	MC0035

**UGELLO GAS PER TWECO 4 MM. 13**

Codice	U.M.	Articolo
9562430	Pezzi	MC0039

**PORTATUBETTO CORTO M6 PER ERGOPLUS 36**

Codice	U.M.	Articolo
9562493	Pezzi	MD0063

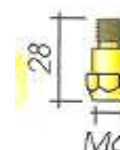
**PORTATUBETTO LUNGO M6 PER ERGOPLUS 36**

Codice	U.M.	Articolo
9562495	Pezzi	MD0131

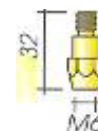
**PORTATUBETTO LUNGO M8 PER ERGOPLUS 36**

Codice	U.M.	Articolo
9562496	Pezzi	MD0132

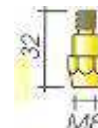
**PORTATUBETTO CORTO PER ERGOPLUS 500**

Codice	U.M.	Articolo
9562509	Pezzi	ME0076

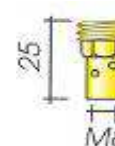
**DIFFUSORE GAS PER ERGOPLUS 15**

Codice	U.M.	Articolo
9562250	Pezzi	FB0117

**DIFFUSORE GAS PER ERGOPLUS 25**

Codice	U.M.	Articolo
9562503	Pezzi	ME0016

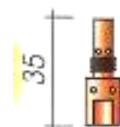

DIFFUSORE GAS PER ERGOPLUS 36

Codice	U.M.	Articolo
9562514	Pezzi	ME0517

**DIFFUSORE GAS CERAMICA PER ERGO 400**

Codice	U.M.	Articolo
9562515	Pezzi	ME0579

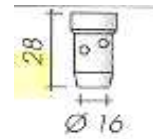
**DIFFUSORE GAS PER TWECO 2**

Codice	U.M.	Articolo
9562505	Pezzi	ME0019

**DIFFUSORE GAS PER TWECO 4**

Codice	U.M.	Articolo
9562506	Pezzi	ME0020

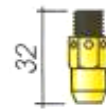
**INTERRUTTORE PER TORCIA ERGOPLUS PRATIX MIG 15**

Codice	U.M.	Articolo
9562076	Pezzi	BX0024

**MOLLA UGELLO PER TORCIA MIG MAG**

Codice	U.M.	Articolo
9562208	Pezzi	EA0303

**MOLLA UGELLO PER TORCIA MIG MAG 6**

Codice	U.M.	Articolo
9562209	Pezzi	EA0304



RICAMBI E ACCESSORI PER TORCIA PLASMA LINCOLN 25

CONFEZIONE 3 DIFFUSORI ARIA

Codice	U.M.	Articolo
5462027	Pezzi	W3X0893-5R

RICAMBI E ACCESSORI PER T100 LINCOLN

CONFEZIONE 3 ANELLI DI TENUTA (1c)

Codice	U.M.	Articolo
5462035	Confez.	WB300264A

CONFEZIONE 5 ELETTRODI (5)

Codice	U.M.	Articolo
5462037	Confez.	WB300123A

CONFEZIONE 5 ANELLI ISOLANTI (6)

Codice	U.M.	Articolo
5462038	Confez.	WB300124A

CONFEZIONE 5 UGELLI MM. 1,35 (7a)

Codice	U.M.	Articolo
5462040	Confez.	WB300126A

CONFEZIONE 5 UGELLI MM. 1,6 (7b)

Codice	U.M.	Articolo
5462041	Confez.	WB300127A

CAPPuccio CERAMICO (14)

Codice	U.M.	Articolo
5462044	Pezzi	WB300138A

CAPPuccio PER SCRICCATURA (30)

Codice	U.M.	Articolo
5462045	Pezzi	WB300132A

CONFEZIONE 5 DISTANZIALI A MOLLA (20)

Codice	U.M.	Articolo
5462050	Pezzi	WB300245A

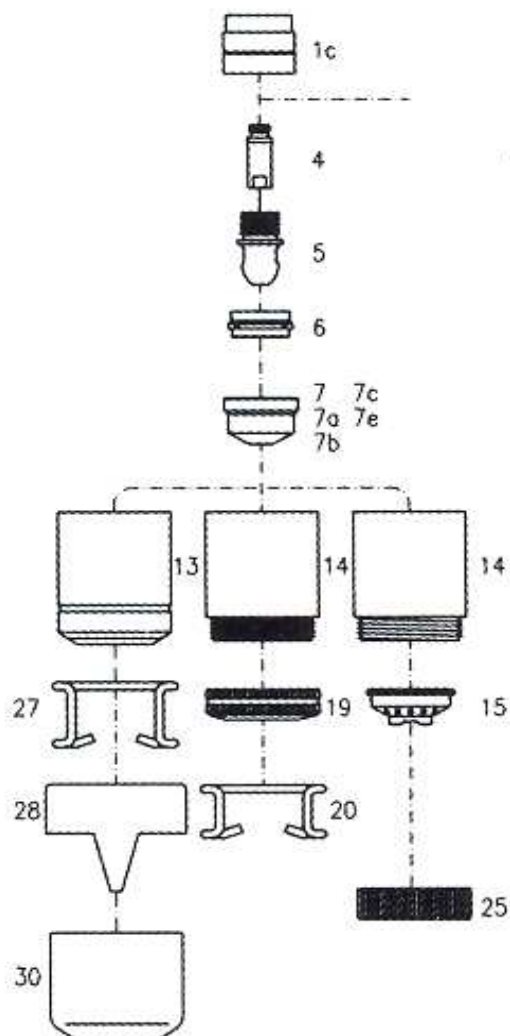

RICAMBI E ACCESSORI PER T70 LINCOLN

CONFEZIONE 10 ELETTRUDI (5)

Codice	U.M.	Articolo
5462015	Confez.	WB300105A

CONFEZIONE 5 ANELLI ISOLANTI (6)

Codice	U.M.	Articolo
5462016	Confez.	WB300106A

CONFEZIONE 10 UGELLI LONG LIFE MM.1,0 (7a)

Codice	U.M.	Articolo
5462017	Confez.	WB300107A

CONFEZIONE 5 ELETTRUDI LUNGH (10)

Codice	U.M.	Articolo
5462021	Confez.	WB300110A

CONFEZIONE 5 UGELLI LUNGH (11c)

Codice	U.M.	Articolo
5462023	Confez.	WB300112A

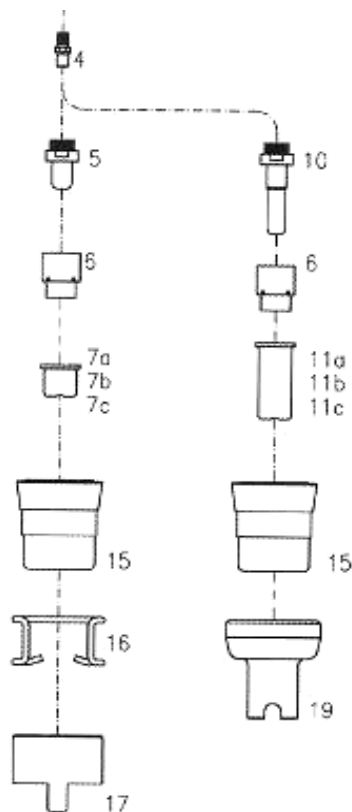

CONFEZIONE 5 UGELLI LUNGH LONG LIFE MM. 0,1 USO DA 30 A 50 AMP.

Codice	U.M.	Articolo
0672004	Confez.	1395



PORTAUGELLO

Codice	U.M.	Articolo
0672014	Confez.	5.710.171



CONFEZIONE 5 MOLLE DISTANZIALI

Codice	U.M.	Articolo
0672015	Confez.	1394



CONFEZIONE 5 ELETTRUDI LUNGH USO DA 20 A 90 AMP.

Codice	U.M.	Articolo
0672024	Confez.	1368



CONFEZIONE 2 DIFFUSORI

Codice	U.M.	Articolo
0672002	Confez.	1396



CORPO TORCIA (TESTINA) PER P70, 1564-1573

Codice	U.M.	Articolo
0672031	Confez.	1351

**CONFEZIONE 5 ELETTRUDI USO DA 15 A 70 AMP.**

Codice	U.M.	Articolo
0672013	Confez.	1402

**CONFEZIONI 5 UGELLI MM.1,8 USO DA 110 A 150 AMP. - PER ART. 1226-1128**

Codice	U.M.	Articolo
0672016	Confez.	1374

**CONFEZIONI 5 ELETTRUDI USO DA 20 A 150 AMP.- PER ART. 1226-1128**

Codice	U.M.	Articolo
0672021	Confez.	1374

**DIFFUSORE PER 1377**

Codice	U.M.	Articolo
0672025	Confez.	1377

**TORCIA PRATIX SINTIG 17 DINSE 50 MT. 4
EN60974-7 CE**

Codice	U.M.	Articolo
9562838	Pezzi	SF1401-03+CX 0077

**TORCIA PRATIX SINTIG 20 DINSE 50 MT. 4
EN60974-7 CE**

Codice	U.M.	Articolo
9562840	Pezzi	SV1410-03

**TORCIA PRATIX SINTIG 26 DINSE 50 MT. 4
EN60974-7 CE**

Codice	U.M.	Articolo
9562843	Pezzi	SK1407-03



TORCIA TIG 17V CON DINSE 25 MT.4
EN60974-7 CE

Codice	U.M.	Articolo
9562837	Pezzi	SH4401+CX0088



PINZA PER TORCIA TIG 17/26 DIAM. MM. 1,6

Codice	U.M.	Articolo
9562885	Pezzi	TD0001-16 10N23



PINZA PER TORCIA TIG 17/26 DIAM. MM. 2,4

Codice	U.M.	Articolo
9562887	Pezzi	TD0001-24 10N24

PINZA PER TORCIA TIG 20 DIAM. 1,6

Codice	U.M.	Articolo
9562891	Pezzi	TD0003-16 13N22



PINZA PER TORCIA TIG 20 DIAM. MM. 2,4

Codice	U.M.	Articolo
9562893	Pezzi	TD0003-24 13N23

PORTAPINZE PER TORCIA TIG 17/26 DIAM. MM. 1,6

Codice	U.M.	Articolo
9562896	Pezzi	TE0001-16 10N31



PORTAPINZE PER TORCIA TIG 17/26 DIAM. MM. 2,4

Codice	U.M.	Articolo
9562897	Pezzi	TE0001-24 10N32

PORTA PINZE PER TORCIA TIG 20 DIAM. MM. 1,6

Codice	U.M.	Articolo
9562900	Pezzi	TE0003-16 13N27

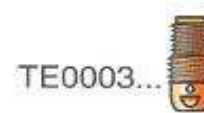

PORTA PINZE PER TORCIA TIG 20 DIAM. MM.2,4

Codice	U.M.	Articolo
9562901	Pezzi	TE0003-24 13N28

CAPPELOTTO LUNGO PER TORCIA TIG 17

Codice	U.M.	Articolo
9562050	Pezzi	BW0066 57 Y02



CAPPELOTTO CORTO PER TORCIA TIG 17

Codice	U.M.	Articolo
9562051	Pezzi	BW0067 57Y04

**CONNETTORE MASCHIO PER TORCIA TIG 5 PIN**

Codice	U.M.	Articolo
9562098	Pezzi	BX0251

**SPINA TIG 25 CON RACCORDO 1/4G**

Codice	U.M.	Articolo
9562160	Pezzi	CX0087

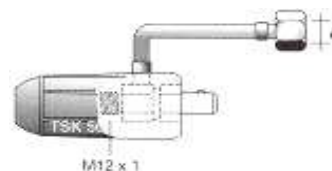
**SPINA TIG 50 CON RACCORDO 1/4G**

Codice	U.M.	Articolo
9562159	Pezzi	CX0077

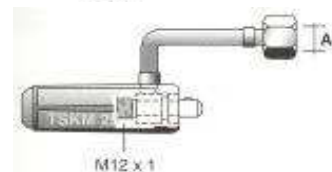
**UGELLO ALL. PER TORCIA TIG 17 DIAM. MM. 6,4**

Codice	U.M.	Articolo
9562866	Pezzi	TC0002 10N50

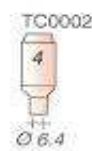
**UGELLO ALL. PER TORCIA TIG 17 DIAM. MM. 8,0**

Codice	U.M.	Articolo
9562867	Pezzi	TC0003 10N49

**UGELLO ALL. PER TORCIA TIG 17 DIAM. MM. 9,5**

Codice	U.M.	Articolo
9562868	Pezzi	TC0004 10N48

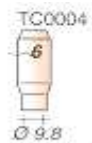
**UGELLO ALL. PER TORCIA TIG 17 DIAM. MM. 11,2**

Codice	U.M.	Articolo
9562869	Pezzi	TC0005 10N47

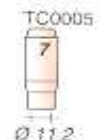
**SPINA TIG 25 CON INNESTO RAPIDO GAS**

Codice	U.M.	Articolo
9562166	Pezzi	CX0090

SPINA TIG 50 CON INNESTO RAPIDO GAS

Codice	U.M.	Articolo
9562165	Pezzi	CX0080